

## KWC ONO E Lever mixer – Washbasin

Modell-Linie: ONO E | 12.578.093.000FL  
Taps | Manual taps

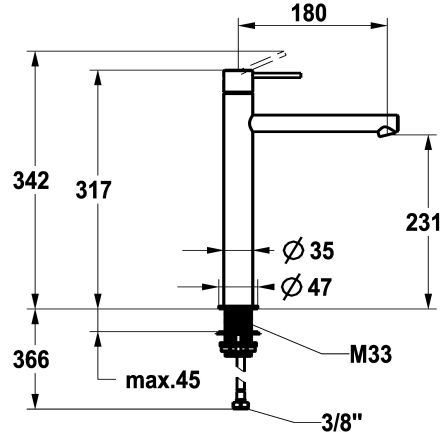

### KWC-No.

**125622**  
chromeline, A180, flexible connection hoses, without pop-up valve

**125623**  
stainless steel, A180, flexible connection hoses, without pop-up valve

- \* Lever mixer
- \* Made of stainless steel
- \* EcoProtect - water-saving device
- \* Fixed spout
- Neoperl® Caché® SSR, swivelling jet regulator
- \* OptimalSpace - ample space for washing or working
- \* KWC cartridge S 25

### Color code

chromeline

stainless steel

NEW

- with ceramic discs
- flow rate and temperature continuously variable
- \* Flexible connection hoses 3/8"
- \* QuickInstallation - Fastening via threaded connection with locking screws
- \* Mounting hole size ø35 mm

### Technical Data

Flow rate	4.3 l/min (3 bar)
pop-up valve	without pop-up valve
Connection	Flexible connection hoses
Spout	fixed
Handling	top lever
Color code	chromeline
Installation type	Pillar installation
Faucet_typ	Faucet
Measure Height	317
Acoustic group	yes
Projection A	A 180
Energy label	A
Dimension Water outlet	231
material	stainless steel

Flow rate	4.3 l/min (3 bar)
pop-up valve	without pop-up valve
Connection	Flexible connection hoses
Spout	fixed
Handling	top lever
Color code	chromeline
Installation type	Pillar installation
Faucet_typ	Faucet
Measure Height	317
Acoustic group	yes
Projection A	A 180
Energy label	A
Dimension Water outlet	231
material	stainless steel



### Spare Parts

## KWC ONO E Lever mixer – Washbasin

Modell-Linie: ONO E | 12.578.093.000FL  
Taps | Manual taps



**Cartridge S 25**

---

**538711**  
Z.536.032

---



**Service key Neoperl © Caché ©, TJ, 18 mm, green**

---

**634729**  
CACHETJ

---