

## KWC HEAVY-DUTY Wall hung WC pan

Modell-Linie: HEAVYDUTY | HDTX594  
WCs and urinals | WCs

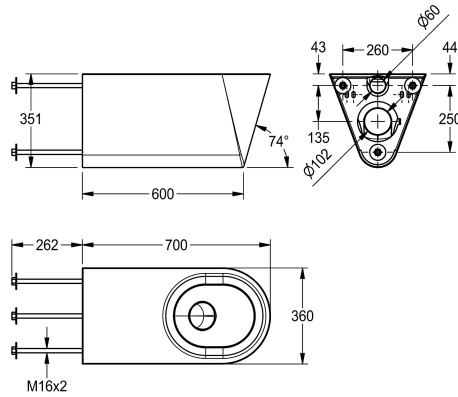

### KWC-No.

**2000100444**

Dimensions 360 x 351 x 700 mm (W x H x D)

Wall hung WC pan for disabled, hidden mounting with stainless steel rods through wall, fixing and service via maintenance room, stainless steel, surface satin finished, material thickness 1,5 mm, flushing certificated to EN 997, concealed flushing rim with min. 4 liter flushing capacity, with a shrouded 100 mm diameter horizontal

'P' trap outlet, pressed seat area tapered towards centre, all edges curved, fixing with 280 mm stainless steel rods and screw nuts (included) through the wall.

Dimensions 360 x 351 x 700 mm (B x H x T)

### Technical Data

inlet size
material
material code
material thickness
minimum flushing capacity
outlet size
overall depth
overall height
overall width
surface finish
type of mounting
type of toilet seat
type of WC

DN 55
stainless steel
1.4301 Chrome Nickel steel V2A
1.5 mm
4 Liter
DN 100
700 mm
351 mm
360 mm
satin finished
bolt fix with duct wall
no seat
wall hung

