

KWC F5E-Mix Electronic pillar mixer with in-wall power supply

Modell-Linie: F5E | F5EM1009
Taps | Electronic taps

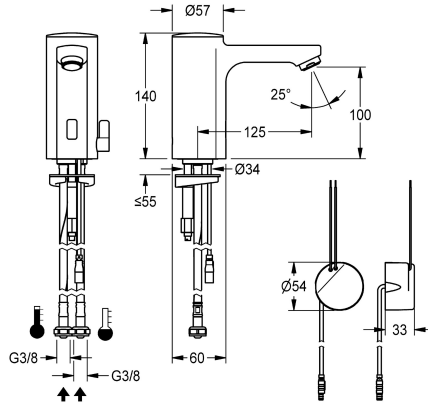

KWC-No.

2030035329

2030039432

with flow regulator 3.0 l/min

volume flow rate at 3 bar

0.08 l/s

0.05 l/s

F5E-Mix pillar mixer DN 15 for sanitary facilities, opto-electronically controlled. For connection to hot and cold water via hoses with integrated backflow preventer and strainers. Control electronics, solenoid valve cartridge and sensor in all-metal housing, high-polished chromium-plated brass. Temperature lever with adjustable, turn-proof temperature stop as well as conversion set

for concealed mixing device. Aerator with integrated flow regulator 3.0 l/min. Activated water hygiene flushing 24 hours after last activation, safety switch-off with continuous reflection and saving of statistical data. With option for parameterization and communication via optional, bidirectional remote control. With in-wall power supply 100 - 240 V AC.

Technical Data

with backflow preventer

calculation flow rate cold wat

calculation flow rate hot wate

compatible A3000 open

default automatic hygiene flus

depressurised

with filter

functional principle

hygiene flushing

diameter nominal

inlet size

Locking mechanism

material fitting

minimum flow pressure

type of mixing

Parameterization

Pop-up waste set

power supply connection

position of power connection

power consumption

Type of power supply

protective system IP

with rosettes/cover plate

yes

0.07 l/s

0.07 l/s

no

24h after the last activity

no

yes

electronic self-closing

yes

DN 15

G 3/8

Top section, non-ceramic

brass-look

1 bar

yes

remote control

no

100 - 240 V AC

from bottom

1.5 Voltampere

Transformer

IP59K

no



KWC F5E-Mix

Electronic pillar mixer with in-wall power supply

Modell-Linie: F5E | F5EM1009

Taps | Electronic taps

protective shutdown	yes
sound insulation	no
Spout	fixed
spout projection	125 mm
surface finish fitting	chromed
surface treatment fitting	polished
temperature limit	yes
thermal disinfection	no
with transformer/power supply	yes
type of mounting	tap hole
type of operation	sensor operation
type of sensor	opto-electronic sensor
type of tap	pillar tap
volume flow rate at 3 bar	0.05 l/s
water connection	hose (gland nut)
Accent colour	none
Basic colour	chrome-look (glossy)

Optional Accessories



Bidirectional remote control for electronic fittings F3 and F5

2030036654
ACEX9005



2-button remote control for fittings F3 and F5

2030036849
ACEX9004



Socket

2030040334
ACEX1001

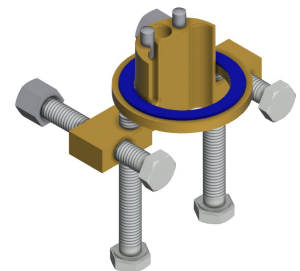

Anti-twist protection for F5S

2030035383
ACXX1001



Extension cable 5 m

2030043814
ACEX9010



PURETHERM under-table thermostat

2030012758
PURE0031

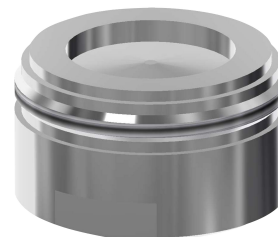

Aerator 1.8 l/min

2030041442
ACXX1005



Theft-proof housing for aerator

2000104778
ZTAPS0005

KWC F5E-Mix Electronic pillar mixer with in-wall power supply

Modell-Linie: F5E | F5EM1009
Taps | Electronic taps

Spare Parts



3.0 l/min. aerator

2030041424
ASXX1008



Cap

2030041558
ASEX1007

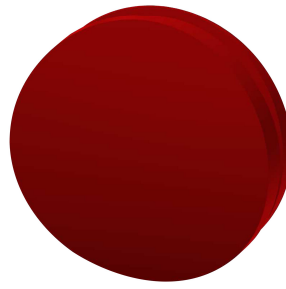

Plug red

2030041951
ASEX1009

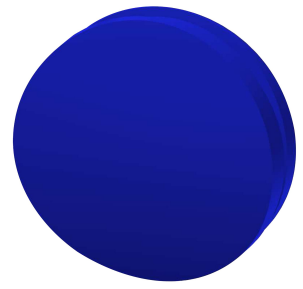

Plug blue

2030041952
ASEX1010

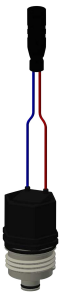

Solenoid valve cartridge

2030045522
ACXX9002



Temperature selection lever

2030041431
ASEM1001



Hose

2030041320
ASXM1001



Quick-action fastener

2030043596
ASEX1013



Water way

2030041949
ASEX1008

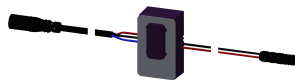

Sensor, ID 01/00004

2030041458
ASEX1005



In-wall power supply

2030039825
ACEX9003