

## KWC F5E-Mix

Electronic pillar mixer with in-wall power supply

Modell-Linie: F5E | F5EM1009

Taps | Electronic taps

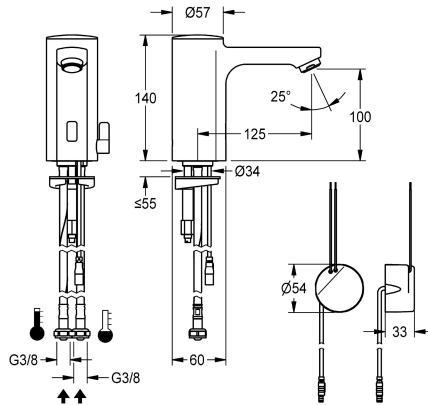

### KWC-No.

2030035329

2030039432

with flow regulator 3.0 l/min

### volume flow rate at 3 bar

0.08 l/s

0.05 l/s

F5E-Mix pillar mixer DN 15 for sanitary facilities, opto-electronically controlled. For connection to hot and cold water via hoses with integrated backflow preventer and strainers. Control electronics, solenoid valve cartridge and sensor in all-metal housing, high-polished chromium-plated brass. Temperature lever with adjustable, turn-proof temperature stop as well as conversion set

for concealed mixing device. Aerator with integrated flow regulator 3.0 l/min. Activated water hygiene flushing 24 hours after last activation, safety switch-off with continuous reflection and saving of statistical data. With option for parameterization and communication via optional, bidirectional remote control. With in-wall power supply 100 - 240 V AC.

### Technical Data

with backflow preventer

calculation flow rate cold wat

calculation flow rate hot wate

compatible A3000 open

default automatic hygiene flus

depressurised

with filter

functional principle

hygiene flushing

diameter nominal

inlet size

Locking mechanism

material fitting

minimum flow pressure

type of mixing

Parameterization

Pop-up waste set

power supply connection

position of power connection

power consumption

Type of power supply

protective system IP

with rosettes/cover plate

yes

0.07 l/s

0.07 l/s

no

24h after the last activity

no

yes

electronic self-closing

yes

DN 15

G 3/8

Top section, non-ceramic

brass

1 bar

yes

remote control

no

100 - 240 V AC

from bottom

1.5 Voltampere

Transformer

IP59K

no



## KWC F5E-Mix

Electronic pillar mixer with in-wall power supply

Modell-Linie: F5E | F5EM1009

Taps | Electronic taps

protective shutdown	yes
sound insulation	no
Spout	fixed
spout projection	125 mm
surface finish fitting	chromed
surface treatment fitting	polished
temperature limit	yes
thermal disinfection	no
with transformer/power supply	yes
type of mounting	tap hole
type of operation	sensor operation
type of sensor	opto-electronic sensor
type of tap	pillar tap
volume flow rate at 3 bar	0.05 l/s
water connection	hose (gland nut)
Accent colour	none
Basic colour	chrome-look (glossy)

### Optional Accessories



**Bidirectional remote control for electronic fittings F3 and F5**

**2030036654**  
ACEX9005



**2-button remote control for fittings F3 and F5**

**2030036849**  
ACEX9004



**Socket**

**2030040334**  
ACEX1001

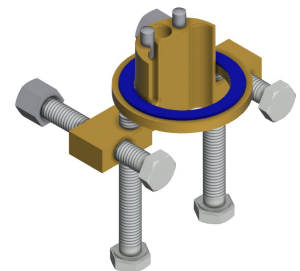

**Anti-twist protection for F5S**

**2030035383**  
ACXX1001



**Extension cable 5 m**

**2030043814**  
ACEX9010



**PURETHERM under-table thermostat**

**2030012758**  
PURE0031

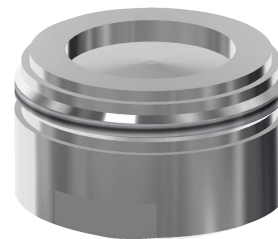

**Aerator 1.8 l/min**

**2030041442**  
ACXX1005



**Theft-proof housing for aerator**

**2000104778**  
ZTAPS0005

## KWC F5E-Mix Electronic pillar mixer with in-wall power supply

Modell-Linie: F5E | F5EM1009  
Taps | Electronic taps

### Spare Parts



3.0 l/min. aerator

2030041424  
ASXX1008



Cap

2030041558  
ASEX1007

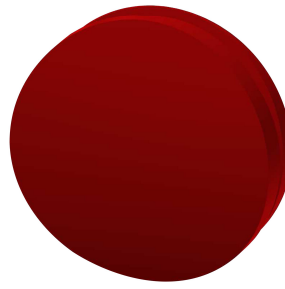

Plug red

2030041951  
ASEX1009

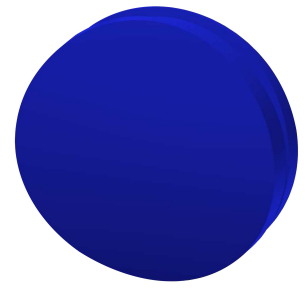

Plug blue

2030041952  
ASEX1010

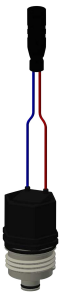

Solenoid valve cartridge

2030045522  
ACXX9002



Temperature selection lever

2030041431  
ASEM1001



Hose

2030041320  
ASXM1001



Quick-action fastener

2030043596  
ASEX1013



Water way

2030041949  
ASEX1008

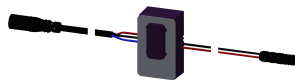

Sensor, ID 01/00004

2030041458  
ASEX1005



In-wall power supply

2030039825  
ACEX9003