

KWC F5E-Mix Electronic pillar mixer for separate power supply

Modell-Linie: F5E | F5EM1010
Taps | Electronic taps

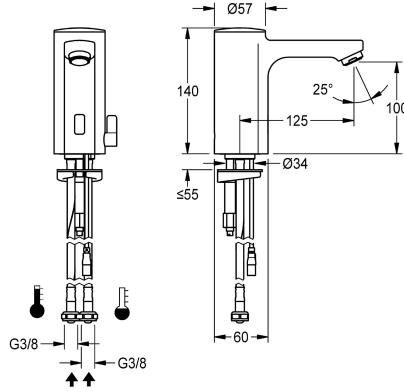

KWC-No.

2030036159

2030039434

with flow regulator 3.0 l/min

volume flow rate at 3 bar

0.08 l/s

0.05 l/s

F5E-Mix pillar mixer DN 15 for sanitary facilities, opto-electronically controlled. For connection to hot and cold water via hoses with integrated backflow preventer and strainers. Control electronics, solenoid valve cartridge and sensor in all-metal housing, high-polished chromium-plated brass. Temperature lever with adjustable, turn-proof temperature stop as well as conversion set for concealed mixing device. Aerator with integrated flow regulator

3.0 l/min. Activated water hygiene flushing 24 hours after last activation, safety switch-off with continuous reflection and saving of statistical data. With option for parameterization and communication via optional, bidirectional remote control. Separate power supply via power supply unit 6.75 V / 12 V DC or AQUA 3000 open system accessories.

Technical Data

with backflow preventer

calculation flow rate cold wat

calculation flow rate hot wate

compatible A3000 open

default automatic hygiene flus

depressurised

with filter

functional principle

hygiene flushing

diameter nominal

inlet size

Locking mechanism

material fitting

minimum flow pressure

type of mixing

Parameterization

Pop-up waste set

power supply connection

position of power connection

power consumption

Type of power supply

protective system IP

yes

0.07 l/s

0.07 l/s

yes

24h after the last activity

no

yes

electronic self-closing

yes

DN 15

G 3/8

Top section, non-ceramic

brass-look

1 bar

yes

remote control

no

6,75 / 12 V DC / A3000 open

from bottom

1.5 Voltampere

Transformer

IP59K

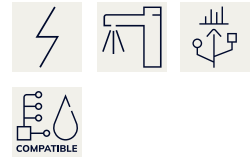

KWC F5E-Mix

Electronic pillar mixer for separate power supply

Modell-Linie: F5E | F5EM1010

Taps | Electronic taps

with rosettes/cover plate	no
protective shutdown	yes
sound insulation	no
Spout	fixed
spout projection	125 mm
surface finish fitting	chromed
surface treatment fitting	polished
temperature limit	yes
thermal disinfection	no
with transformer/power supply	no
type of mounting	tap hole
type of operation	sensor operation
type of sensor	opto-electronic sensor
type of tap	pillar tap
volume flow rate at 3 bar	0.05 l/s
water connection	hose (gland nut)
Accent colour	none
Basic colour	chrome-look (glossy)

Mandatory Accessories

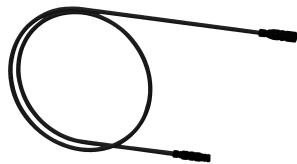
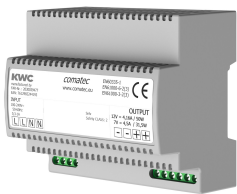

Power supply unit

2030039477
ACEX9001

Extension cable 5 m

2030043814
ACEX9010

Optional Accessories

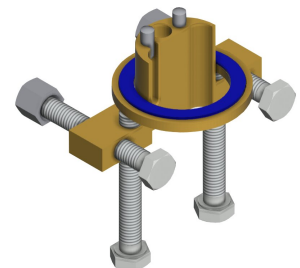

KWC F5E-Mix

Electronic pillar mixer for separate power supply

Modell-Linie: F5E | F5EM1010

Taps | Electronic taps

**Bidirectional remote control for
electrical fittings F3 and F5**

2030036654
ACEX9005

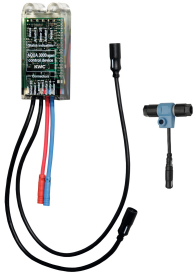

**2-button remote control for fittings F3
and F5**

2030036849
ACEX9004

Socket

2030040334
ACEX1001



Anti-twist protection for F5S

2030035383
ACXX1001



**Electronic module for wash basin taps
F5**

2030041520
ACEX1002

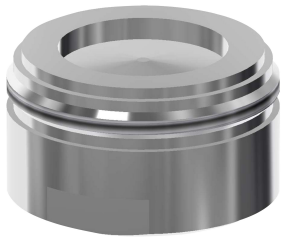

**Electronic module EM5 with ID 02010,
with flush box**

2030059118
ACEX1004



PURETHERM under-table thermostat

2030012758
PURE0031



5.0 l/min aerator, angle-adjustable

2030041326
ACXX1002



Aerator 1.8 l/min

2030041442
ACXX1005



Theft-proof housing for aerator

2000104778
ZTAPS0005



Spare Parts

3.0 l/min. aerator

2030041424



Cap

2030041558



Plug red

2030041951

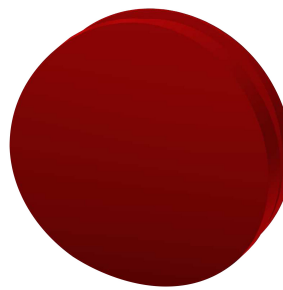

Plug blue

2030041952

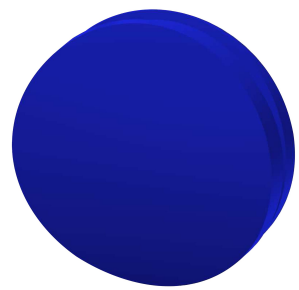

KWC F5E-Mix

Electronic pillar mixer for separate power supply

Modell-Linie: F5E | F5EM1010

Taps | Electronic taps

ASXX1008

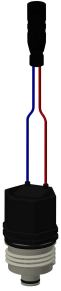

Solenoid valve cartridge

2030045522
ACXX9002

ASEX1007



Temperature selection lever

2030041431
ASEM1001

ASEX1009



Hose

2030041320
ASXM1001

ASEX1010

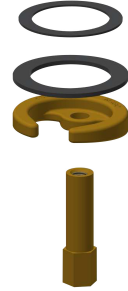

Quick-action fastener

2030043596
ASEX1013



Water way

2030041949
ASEX1008

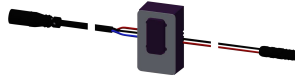

Sensor, ID 01/00004

2030041458
ASEX1005