

KWC

F3E electronic pillar tap for separate power supply

Modell-Linie: F3E | F3EV1005

Taps | Electronic taps

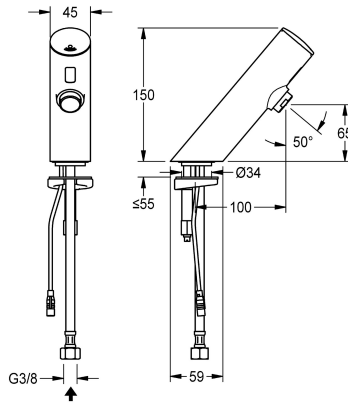

KWC-No.

2030039459

2030039465

with flow regulator 3.0 l/min

volume flow rate at 3 bar

0.1 l/s

0.05 l/s

F3E pillar tap DN 15 for sanitary facilities, opto-electronically controlled. For connection to pre-mixed hot or cold water via hose and strainer. Control electronics, solenoid valve cartridge and sensor in all-metal housing, high-polished chromium-plated brass. Aerator with integrated flow regulator 6.0 l/min. Activated water hygiene

flushing 24 hours after last activation, safety switch-off with continuous reflection and saving of statistical data. With option for parameterization and communication via optional, bidirectional remote control. Separate power supply via power supply unit 6.75 V / 12 V DC.

Technical Data

with backflow preventer

no

calculation flow rate cold wat

0.1 l/s

compatible A3000 open

no

default automatic hygiene flus

24h after the last activity

depressurised

no

with filter

yes

functional principle

electronic self-closing

hygiene flushing

yes

diameter nominal

DN 15

inlet size

G 3/8

Locking mechanism

Top section, non-ceramic

material fitting

brass-look

minimum flow pressure

1 bar

type of mixing

no

Parameterization

remote control

Pop-up waste set

no

power supply connection

6.75 / 12 VDC

position of power connection

from bottom

power consumption

1.5 Voltampere

Type of power supply

Transformer

protective system IP

IP59K

with rosettes/cover plate

no

protective shutdown

yes

sound insulation

no



KWC

F3E electronic pillar tap for separate power supply

Modell-Linie: F3E | F3EV1005

Taps | Electronic taps

Spout	fixed
spout projection	100 mm
surface finish fitting	chromed
surface treatment fitting	polished
temperature limit	no
thermal disinfection	no
with transformer/power supply	no
type of mounting	tap hole
type of operation	sensor operation
type of sensor	opto-electronic sensor
type of tap	pillar tap
volume flow rate at 3 bar	0.1 l/s
water connection	hose (gland nut)
Accent colour	none
Basic colour	chrome-look (glossy)

Mandatory Accessories

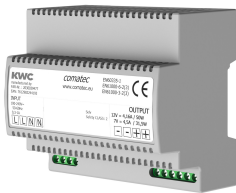

Power supply unit

2030039477
ACEX9001

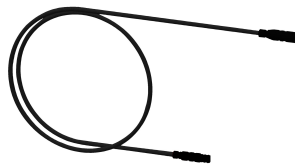

Extension cable 5 m

2030043814
ACEX9010

Optional Accessories



Bidirectional remote control for
electronical fittings F3 and F5

2030036654



2-button remote control for fittings F3
and F5

2030036849



Aerator

2000101160
ZAQUA087



PURETHERM under-table thermostat

2030012758
PURE0031

KWC

F3E electronic pillar tap for separate power supply

Modell-Linie: F3E | F3EV1005
Taps | Electronic taps

ACEX9005

ACEX9004

Spare Parts



Cap for F3E

2030041514
ASEX1006



O-ring, red

2030042439
ASEV1002



O-ring, blue

2030042440
ASEV1002

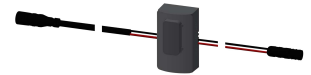

Sensor, ID 01/00001

2030041447
ASEX1001

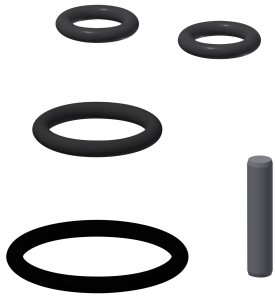

Spare part set

2030042426
ASEX1011

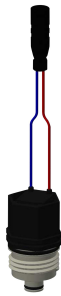

Solenoid valve cartridge

2030003033
EAQFU0001

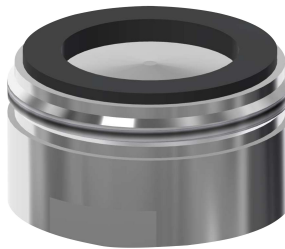

Aerator 6.0 l/min

2000104691
ASXX1015



Hose

2030041501
ASEV1001



Quick-action fastener

2030042441
ASEX1012



Lithium battery 6 V

2000104846
EPRTR0008



Plug-in power supply unit

2030039823
ACEX9002



In-wall power supply

2030039825
ACEX9003