

KWC F5E-Therm Electronic thermostat wall-mounted mixer

Modell-Linie: F5E | F5ET1017
Taps | Electronic taps

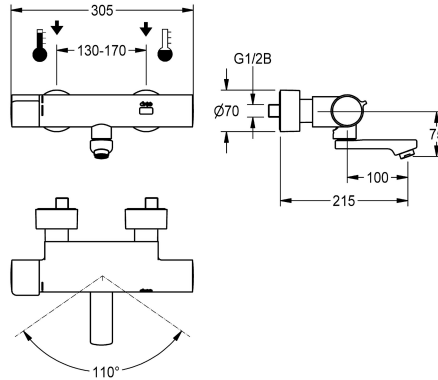

KWC-No.
2030032981 Projection 215 mm
2030032980 Projection 155 mm
2030032983 Projection 275 mm
2030039527 with projection 155 mm and pre-installed disinfection unit
2030039528 with projection 215 mm and pre-installed disinfection unit
2030039529 with projection 275 mm and pre-installed disinfection unit

spout projection
215 mm
155 mm
275 mm
155 mm
215 mm
275 mm

thermal disinfection
yes
yes
yes
automatic thermal disinfection
automatic thermal disinfection
automatic thermal disinfection

F5E-Therm thermostatic mixer DN 15 for wall mounting with lockable swivelling spout, for sanitary facilities. Opto-electronically controlled, triggered via hand movement. Thermostat with metal handle with adjustable and turn-proof temperature stop. With option for thermal disinfection, manually or automatically via pre-assembled disinfection unit. For connection to hot and cold water. Control electronics, solenoid valve cartridge, 6 V lithium battery (CR-P2) and sensor in scald-protected safe-touch housing, high-

polished chromium-plated brass. Laminar jet controller with integrated flow regulator 6.0 l/min. With adjustable and lockable connections with backflow preventer and strainers, completely covered with depth-adjustable screw rosettes. Projection 215 mm. Activated water hygiene flushing 24 hours after last activation, safety switch-off with continuous reflection and saving of statistical data. With option for parameterization and communication via optional, bidirectional remote control.

Technical Data
with backflow preventer
calculation flow rate cold wat
calculation flow rate hot wate
compatible A3000 open
default automatic hygiene flus
default flow time
depressurised
with filter
adjustable flow time
functional principle
hygiene flushing
diameter nominal
inlet size
Locking mechanism
material fitting
maximum flow time

yes
0.07 l/s
0.07 l/s
no
24h after the last activity
10 Seconds
no
yes
yes
electronic self-closing
yes
DN 15
G 1/2 B
Top section, non-ceramic
brass
255 Seconds

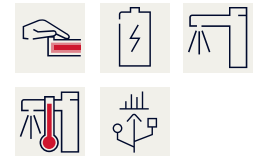

KWC F5E-Therm Electronic thermostat wall-mounted mixer

Modell-Linie: F5E | F5ET1017
Taps | Electronic taps

minimum flow pressure	1 bar
minimum flow time	1 Seconds
type of mixing	with thermostat
number of batteries	1
Parameterization	remote control
Pop-up waste set	no
power supply connection	Battery 6 V
power consumption	1.5 Voltampere
Type of power supply	Battery
protective system IP	IP59K
with rosettes/cover plate	yes
protective shutdown	yes
sound insulation	no
Spout	rotating, bottom
spout projection	215 mm
surface finish fitting	chromed
surface treatment fitting	polished
temperature limit	yes
thermal disinfection	automatic thermal disinfection
with transformer/power supply	no
type of batteries	CR-P2 Lithium battery 6V
type of mounting	wall mounting
type of operation	sensor operation
type of sensor	opto-electronic sensor
type of tap	bib tap
Volume flow rate bypass PWH	0.05 l/s
volume flow rate at 3 bar	0.1 l/s
water connection	S-unions
Accent colour	none
Basic colour	chrome-look (glossy)

Optional Accessories



Bidirectional remote control for electronic fittings F3 and F5

2030036654
ACEX9005



2-button remote control for fittings F3 and F5

2030036849
ACEX9004



Theft-proof housing for aerator

2000104778
ZTAPS0005

KWC F5E-Therm Electronic thermostat wall-mounted mixer

Modell-Linie: F5E | F5ET1017
Taps | Electronic taps

Spare Parts

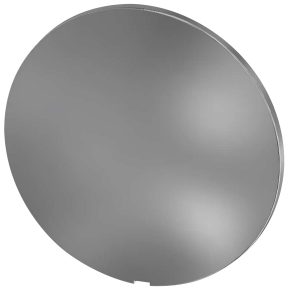

Cover

2030003258
EAQLT0002



Temperature handle

2030050541
ASXT9004

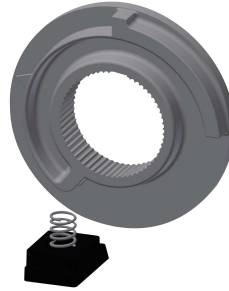

Temperature stop

2030003296
EAQLT0003

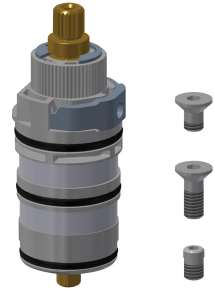

Thermocouple

2030003300
EAQLT0004



Swivel spout, 100 mm

2030032671
ASXX1001



Laminar jet regulator

2030012352
ETAPS0037

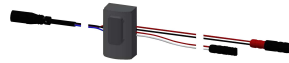

Sensor, ID 02/00002

2030041459
ASXT9001



Solenoid valve cartridge

2030045522
ACXX9002



Lithium battery 6 V

2000104846
EPRTR0008



Mounting set

2030003401
EAQLT0009

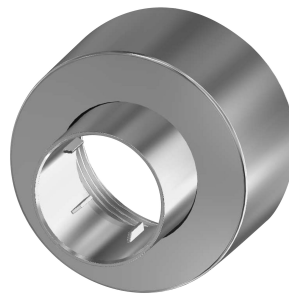

Screw rosette

2030046777
ASXX9003