

KWC

Hygiene unit for F5L single-lever in-wall mixer

Modell-Linie: F5 | ACLM2001

Showers | Complementary parts showers

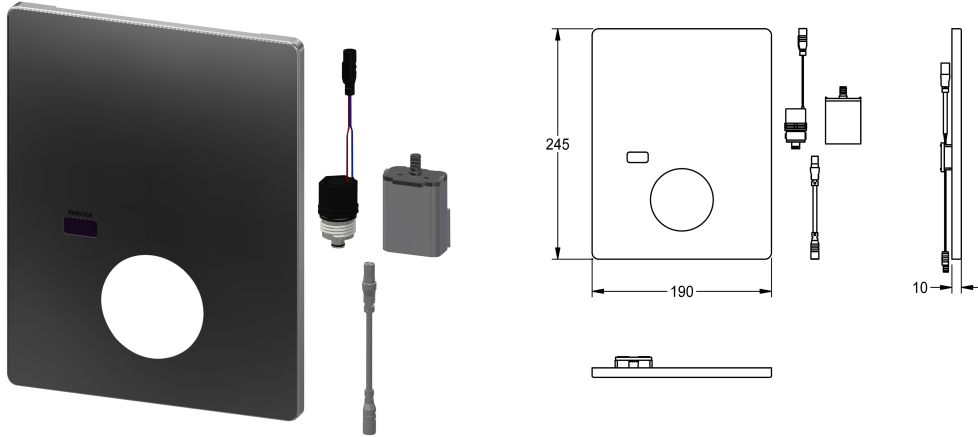

KWC-No.

2030041526

Hygiene unit including 6 V lithium battery

Hygiene unit for F5L single-lever mixers as in-wall mixer for shower facilities, for performing of automatic hygiene flushing and program-controlled thermal disinfection (additional bypass solenoid cartridge necessary) and storage of statistical data. Stainless steel cover plate 190 x 245 mm including sensor with control electronics

and 6 V lithium battery (CR-P2) as well as solenoid valve cartridge. Activated water hygiene flushing (30 s), fixed interval time 24 hours and saving of statistical data. With option for parameterization and communication via optional, bidirectional remote control.

Technical Data

number of batteries

1

quantity

1

quantity uom

piece

type of batteries

CR-P2 Lithium battery 6V

Optional Accessories



Bidirectional remote control for electronic fittings F3 and F5

2030036654

ACEX9005



2-button remote control for fittings F3 and F5

2030036849

ACEX9004



Solenoid valve cartridge

2030003033

EAQFU0001

Spare Parts

KWC

Hygiene unit for F5L single-lever in-wall mixer

Modell-Linie: F5 | ACLM2001

Showers | Complementary parts showers



Cover plate stainless steel

2030045819
ASLM2006

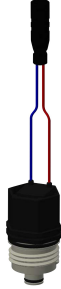

Solenoid valve cartridge

2030003033
EAQFU0001



Lithium battery 6 V

2000104846
EPRTR0008



Battery compartment

360002063
ACEX9023

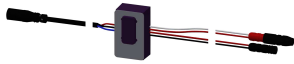

Sensor, ID 81/00001

2030041484
ASLM2001