

KWC PLANOX

Wash trough

Modell-Linie: PLANOX | PL18

Washbasins & Washtroughs | Washtroughs

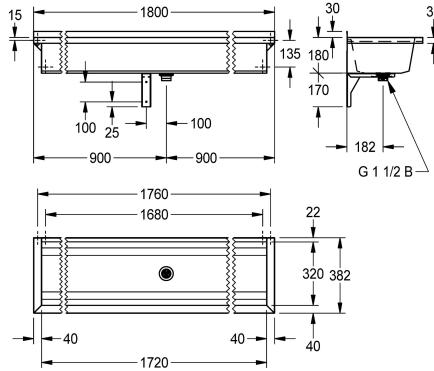
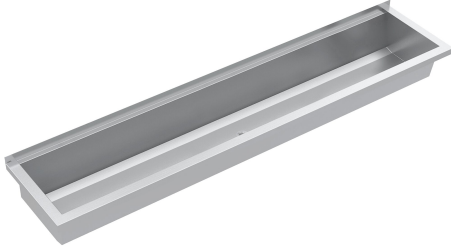

KWC-No.

2030043777

Length 600 mm

2030043778

Length 800 mm

2030043779

Length 1200 mm

2030043780

Length 1600 mm

2030043781

Length 1800 mm

2030043782

Length 2400 mm

2030043783

Length 3000 mm

overall width

600 mm

800 mm

1,200 mm

1,600 mm

1,800 mm

2,400 mm

3,000 mm

PLANOX seamless welded washtrough for wall mounting, chromium nickel steel, satin finished surface, material thickness of washtrough 0.8 mm / side panels 1.2 mm, side panels with integrated wall brackets, without tap ledge or overflow, 40 mm rear upstand, central waste, G 1 1/2 B strainer waste, includes mounting

materials. For a length of 1800 mm or more, an additional bracket is supplied. Special lengths are available on request.

Dimensions 1800 x 210 x 382 mm (W x H x D)

Technical Data

splash back height

30 mm

bowl - bowl height

180 mm

bowl - depth

320 mm

bowl - width

1,720 mm

material

stainless steel

material code

1.4301 Chrome Nickel steel V2A

number of waste holes

1

overall depth

382 mm

overall height

210 mm

overall width

1,800 mm

rear upstand

no

splash back

optional

surface finish

satin finished

tap ledge

no

type of mounting

wall mounting

type of waste kit

perforated waste

KWC PLANOX

Wash trough

Modell-Linie: PLANOX | PL18

Washbasins & Washtroughs | Washtroughs

waste hole position

centre

waste hole projection

182 mm

waste kit included

yes

Optional Accessories



PLANOX splash back

2030043809
PL18SB



Bracket for PLANOX washtroughs

2030043812
PL18SU



SATURN Shelf

2000056950
BXS18



SATURN set of towel rails

2000101452
TB60

Spare Parts

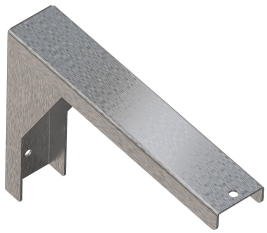

Bracket for PLANOX washtroughs

2030043812
PL18SU