

## KWC F5S-Therm Stainless steel shower panel with hand shower fitting

Modell-Linie: F5S | F5ST2021  
Showers | Self closing showers

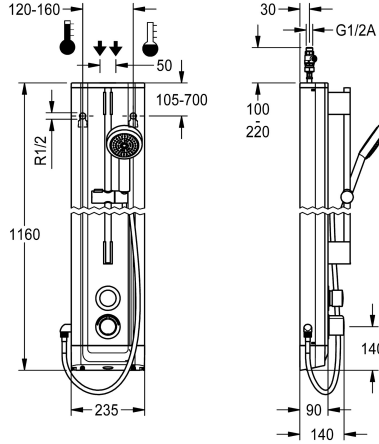

### KWC-No.

2030056539

F5S Therm shower panel made of stainless steel for wall mounting with DN 15 self-closing thermostatic mixer and connecting nozzles for a hand shower fitting. Hydraulically controlled, for connection to hot water and cold water. Shower valve with integrated FRAMIC self-closing cartridge, thermostat and pre-assembled hygiene unit including sensor with control electronics to perform automatic water hygiene flushing, with program-controlled thermal disinfection (additional bypass solenoid-operated flush valve cartridge required) and storage of statistical data. FRAMIC self-closing cartridge, low maintenance and stagnation free, with ceramic disc technology, self-closing, flow pressure independent due to the medium-independent design. Stepless adjustment of flow duration. Thermostat with metal handle, an adjustable and turn-proof temperature stop and an option for manual thermal disinfection. All-metal construction, visible parts high-polished or chrome-plated. Pre-fitted chrome-plated brass shower pole with height-adjustable

hand shower holder and chrome-plated plastic hand shower, shower head with rain jet, diameter 110 mm, shower hose 900 mm. Housing made of stainless steel with raised function surface and plastic cover caps. Connecting hoses with lockable water volume control with backflow preventer and strainer. Activated water hygiene flushing at fixed intervals of 24 hours. With option for parameterization and communication via the optional bidirectional remote control. Optional hygiene unit for battery operation with 6 V lithium battery (CR-P2) per fitting or separate power supply via plug-in power supply unit 6.75 V/12 V DC.

Dimensions of housing 235 x 1160 x 90 mm (W x H x D)

Battery compartment including battery or plug-in power supply unit with extension cable to be ordered separately.

### Technical Data

additional connections
with backflow preventer
circulation
compatible A3000 open
connection with pay water disp
default automatic hygiene flus
with filter
adjustable flow time
functional principle
for hand shower
hygiene flushing
diameter nominal
inlet size
Locking mechanism
material casing
material code casing
material fitting
maximum flow time
minimum flow pressure

No
Yes
No
No
not possible
fixed interval 24 hours
Yes
Yes
hydraulic self-closing
Yes
Yes
DN 15
G 1/2 A
Top section, ceramic
stainless steel
1.4301 Chrome Nickel steel V2A
brass-look
35 Seconds
1 bar

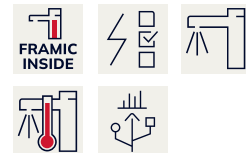

## KWC F5S-Therm

Stainless steel shower panel with hand shower fitting

Modell-Linie: **F5S | F5ST2021**  
Showers | Self closing showers

minimum flow time	5 Seconds
type of mixing	with thermostat
overall depth	90 mm
overall height	1,160 mm
overall width	235 mm
Parameterization	remote control
power supply connection	6,75 / 12 VDC
position of power connection	from top / backside
Type of power supply	Other
with rosettes/cover plate	Yes
protective shutdown	No
shower pipe draining	No
with shower set	Yes
sound insulation	No
surface finish casing	satin finished
surface finish fitting	chromed
surface treatment fitting	polished
temperature limit	Yes
thermal disinfection	Yes
with transformer/power supply	No
type of mounting	wall mounting
type of operation	manual operation
type of sensor	opto-electronic sensor
type of shower	shower panel
water connection	hose (gland nut)
position of water connection	from top / backside
with soap dish	No
Accent colour	chrome-look (glossy)
Basic colour	stainless steel-look

### Mandatory Accessories



#### Battery compartment

**3600002063**  
ACEX9023

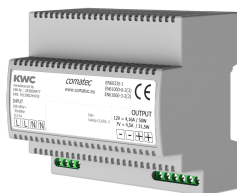

#### Power supply unit

**2030039477**  
ACEX9001

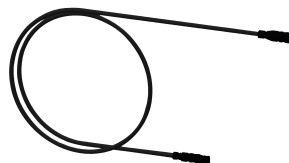

#### Extension cable 5 m

**2030043814**  
ACEX9010

### Optional Accessories

## KWC F5S-Therm

Stainless steel shower panel with hand shower fitting

Modell-Linie: F5S | F5ST2021  
Showers | Self closing showers

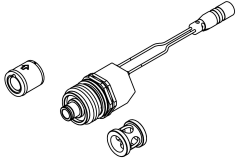

Set for thermal disinfection

**2030057940**  
ACXT2001



Bidirectional remote control for electrical fittings F3 and F5

**2030036654**  
ACEX9005



2-button remote control for fittings F3 and F5

**2030036849**  
ACEX9004

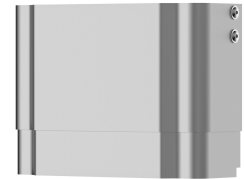

Housing extension for F5 shower panels made of stainless steel

**2030057066**  
ACXX2011

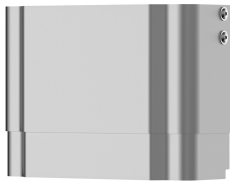

Housing extension for F5 shower panels made of stainless steel

**2030057067**  
ACXX2012

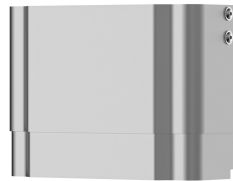

Housing extension for F5 shower panels made of stainless steel

**2030057068**  
ACXX2013

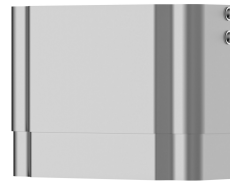

Housing extension for F5 shower panels made of stainless steel

**2030057069**  
ACXX2014

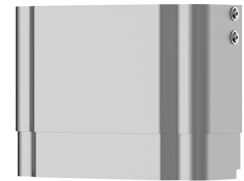

Housing extension for F5 shower panels made of stainless steel

**2030057070**  
ACXX2015



Shower gel dish for F5 shower panels made of stainless steel

**2030057077**  
ACXX2021

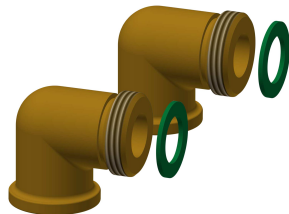

Connection set for shower panel

**2000104916**  
ZSHOW0006



Connection adapter

**2000101441**  
AQRM928

## Spare Parts

## KWC F5S-Therm

Stainless steel shower panel with hand shower fitting

Modell-Linie: F5S | F5ST2021  
Showers | Self closing showers



Hand shower

**2030051216**  
ACXX2007



Cover

**2030031443**  
ESHOW0059



Temperature handle

**2030047082**  
ASXT9003

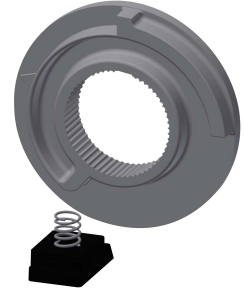

Temperature stop

**2030003296**  
EAQLT0003



Plug chromed

**2030053006**  
ASSX9004



Push cap

**2030049943**  
ASST2001



Safety ring

**2030048357**  
ASSX9003

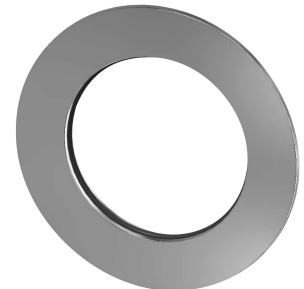

Rosette

**2030048765**  
ASET2006



FRAMIC Self-closing cartridge

**2030046145**  
ASSX9001

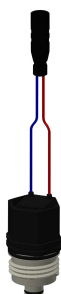

Solenoid valve cartridge

**2030003033**  
EAQFU0001



Stainless steel care set

**2000109019**  
ZWSPL0024



Cleaning product CHROMOL

**2000105091**  
ZWSPL0023