

## KWC

Housing extension for F5 shower panels made of stainless steel

Modell-Linie: **SHOWER-ACCESSORY | ACXX2015**

Showers | Complementary parts showers

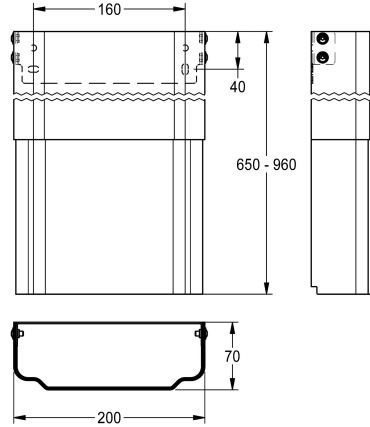

### KWC-No.

---

**2030057066**

Housing dimensions approx. 200 x 110–170 mm (W x H)

---

**2030057067**

Housing dimensions approx. 200 x 160–250 mm (W x H)

---

**2030057068**

Housing dimensions approx. 200 x 240–410 mm (W x H)

---

**2030057069**

Housing dimensions approx. 200 x 400–660 mm (W x H)

---

**2030057070**

Housing dimensions approx. 200 x 650–960 mm (W x H)

---

Housing extension made of stainless steel, height-adjustable, for F5 shower panels made of stainless steel, to cover wall-mounted pipe installations, includes mounting materials.

Housing dimensions approx. 200 x 650–960 mm (W x H)