

KWC

Housing extension for F5 shower panels made of MIRANIT

Modell-Linie: F5 | ACXX2017

Showers | Complementary parts showers

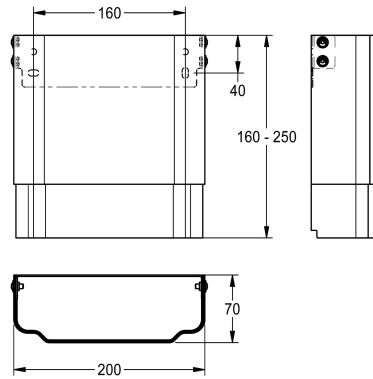

KWC-No.

2030057071

Housing dimensions approx. 200 x 110–170 mm (W x H)

2030057072

Housing dimensions approx. 200 x 160–250 mm (W x H)

2030057073

Housing dimensions approx. 200 x 240–410 mm (W x H)

2030057075

Housing dimensions approx. 200 x 400–660 mm (W x H)

2030057076

Housing dimensions approx. 200 x 650–960 mm (W x H)

Housing extension made of stainless steel, powder-coated Alpine white colour, height-adjustable, for F5 shower panels made of MIRANIT mineral material, to cover wall-mounted pipe installations,

includes mounting material.

Housing dimensions approx. 200 x 160–250 mm (W x H)