

## KWC F5L-Therm thermostatic single-lever in-wall mixer

Modell-Linie: F5L | F5LT2005  
Showers | Manual shower

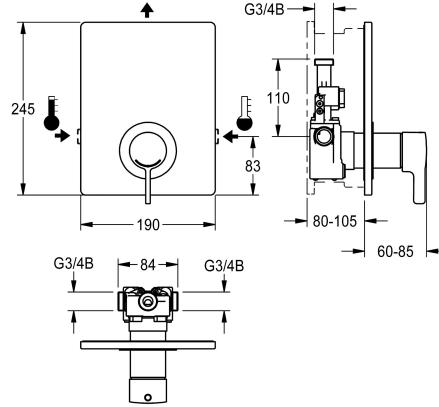

### KWC-No.

**2030066500**

F5L-Therm thermostatic single-lever mixer DN 15 as finished installation kit for in-wall installation in basic installation kit, for shower facilities. For connection to hot and cold water. Function block with integrated thermostatic cartridge and mechanism for an optional hygiene unit for automatic hygiene flushing, program-controlled thermal disinfection (additional bypass solenoid valve cartridge necessary) and storage of statistical data.

Thermostatically-controlled mixer cartridge with expansion element and active scald protection as well as adjustable and turn-proof temperature stop, and ceramic disc technology. All-metal construction, visible parts high-polished, chrome-plated. Holding frame including profile seal, stainless-steel cover plate 190 x 245 mm with covered screw fixing, chrome-plated plastic rosette, backflow preventer and strainers. Depth adjustability 25 mm.

### Technical Data

additional connections

no

with backflow preventer

yes

Built-in fitting model

Finishing section

circulation

no

connection with pay water disp

not possible

Cover plate height

245 mm

Cover plate width

190 mm

with filter

yes

functional principle

manual

for hand shower

no

hygiene flushing

prepared

diameter nominal

DN 15

inlet size

G 3/4 B

Locking mechanism

Top section, ceramic

material casing

stainless steel

material fitting

brass-look

minimum flow pressure

1 bar

type of mixing

with thermostat

with rosettes/cover plate

yes

protective shutdown

no

shower pipe draining

no

sound insulation

no

surface finish casing

satin finished

surface finish fitting

chromed



## KWC

### F5L-Therm thermostatic single-lever in-wall mixer

Modell-Linie: F5L | F5LT2005  
Showers | Manual shower

surface treatment fitting	polished
temperature limit	yes
thermal disinfection	yes
with transformer/power supply	no
type of mounting	in-wall installation with box
type of operation	manual operation
type of shower	in-wall fitting
volume flow rate at 3 bar	0.23 l/s
water connection	threaded connection (external)
position of water connection	from side
Accent colour	chrome-look (glossy)
Basic colour	stainless steel-look

### Mandatory Accessories

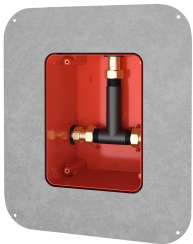

#### R5 System box for in-wall mixer

**2030028990**  
F5BX2001

### Optional Accessories

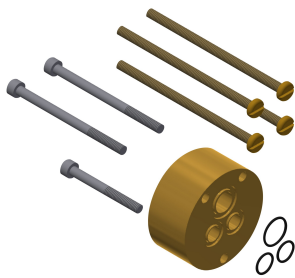

#### Extension set for F5L DN 15 single lever mixer

**2030044779**  
ACLM2002

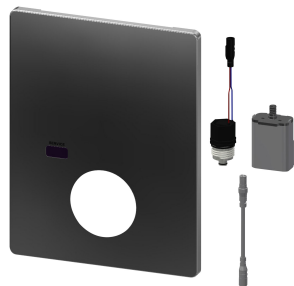

#### Hygiene unit for F5L single-lever in-wall mixer

**2030041526**  
ACLM2001

### Spare Parts

## KWC

F5L-Therm thermostatic single-lever in-wall mixer

Modell-Linie: F5L | F5LT2005  
Showers | Manual shower

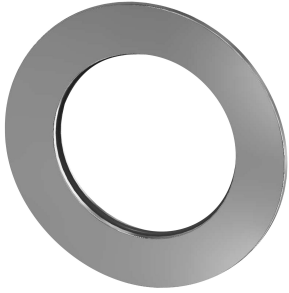

**Rosette**

**2030048765**  
ASET2006

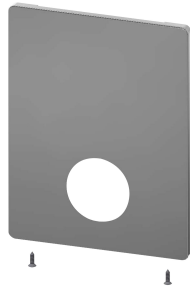

**Cover plate stainless steel**

**2030045475**  
ASXM2001

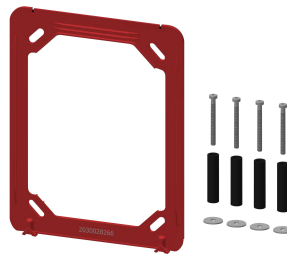

**Holding frame**

**2030045472**  
ASXX9004



**Stainless steel care set**

**2000109019**  
ZWSPL0024



**Cleaning product CHROMOL**

**2000105091**  
ZWSPL0023



**Backflow preventer DN 6**

**2030045816**  
ASXX9002

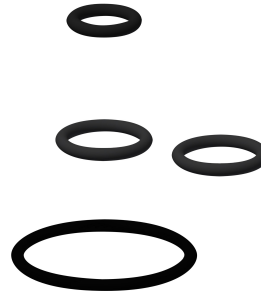

**Spare part set**

**2030045818**  
ASLM2005