

KWC F5L-Therm Stainless steel shower panel

Modell-Linie: F5L | F5LT2022
Showers | Manual shower

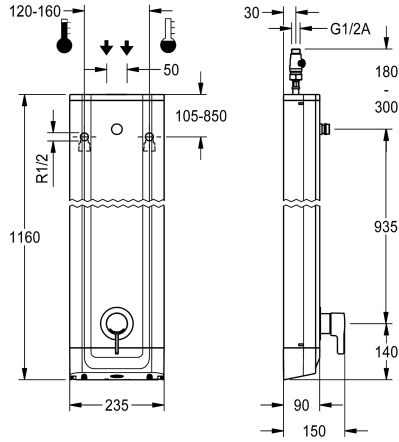

KWC-No.

2030066541

F5L-Therm stainless-steel shower panel for wall mounting with single-lever thermostat DN 15 and connecting nozzle for shower head. For connection to hot and cold water. Function block with integrated mixing cartridge and mechanism for an optional water hygiene unit for automatic water hygiene flushing, program-controlled thermal disinfection (additional bypass solenoid-operated flush valve cartridge necessary) and storage of statistical data. Thermostatically-controlled mixer cartridge with expansion element and active scald protection as well as adjustable and turn-proof temperature stop, and ceramic disc technology. All-metal

construction, visible parts high-polished, chrome-plated. Connecting nozzles for separate required DN 15 KWC shower head with pre-fitted flow regulator 9.0 l/min. Stainless steel housing with raised function surface and cover caps made of plastic. With adjustable and lockable connections with backflow preventer and strainers.

Housing dimensions 235 x 1160 x 90 mm (W x H x D)

Shower head must be ordered separately.

Technical Data

additional connections	no
with backflow preventer	yes
circulation	no
compatible A3000 open	no
connection with pay water disp	not possible
with filter	yes
adjustable flow time	no
functional principle	manual
for hand shower	no
hygiene flushing	prepared
diameter nominal	DN 15
inlet size	G 1/2 A
Locking mechanism	Top section, ceramic
material casing	stainless steel
material code casing	1.4301 Chrome Nickel steel V2A
material fitting	brass
minimum flow pressure	1 bar
type of mixing	with thermostat
overall depth	90 mm
overall height	1,160 mm
overall width	235 mm
with rosettes/cover plate	yes



KWC F5L-Therm Stainless steel shower panel

Modell-Linie: F5L | F5LT2022
Showers | Manual shower

protective shutdown	no
shower pipe draining	no
Shower head	for separately shower head
with shower set	no
sound insulation	no
surface finish casing	satin finished
surface finish fitting	chromed
surface treatment fitting	polished
temperature limit	yes
thermal disinfection	yes
type of mounting	wall mounting
type of operation	manual operation
type of shower	shower panel
volume flow rate at 3 bar	0.15 l/s
water connection	hose (gland nut)
position of water connection	from top / backside
with soap dish	no
Accent colour	chrome-look (glossy)
Basic colour	stainless steel

Mandatory Accessories



AQUAJET-Slimline shower head for KWC shower panels and systems

2030054255
SHAS0011



AQUAJET-Comfort shower head for KWC shower panels and systems

2030054254
SHAC0011

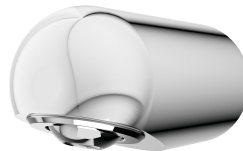

MÜNCHEN shower head for KWC shower panels and systems

2030054793
SHMU0011

Optional Accessories

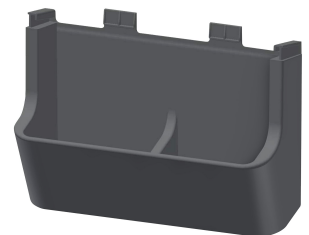
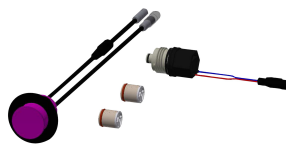
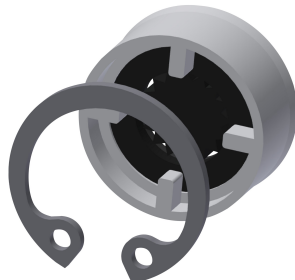
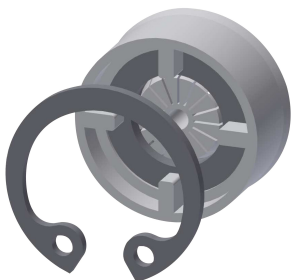

KWC F5L-Therm Stainless steel shower panel

Modell-Linie: F5L | F5LT2022
Showers | Manual shower

Flow controller 6.0 l/min

2030027586
ESHHE0004

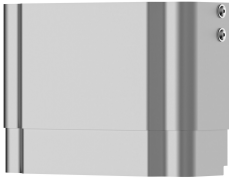

Flow controller 12.0 l/min

2000104783
ESHHE0002

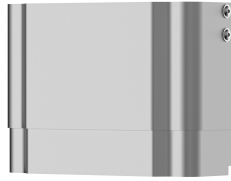

Hygiene unit for F5L single lever mixer shower panel

2030057065
ACLM2003

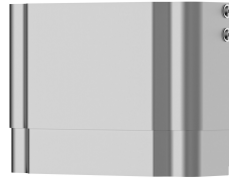

Shower gel dish for F5 shower panels made of stainless steel

2030057077
ACXX2021

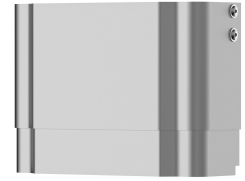

Housing extension for F5 shower panels made of stainless steel

2030057066
ACXX2011



Housing extension for F5 shower panels made of stainless steel

2030057067
ACXX2012

Housing extension for F5 shower panels made of stainless steel

2030057068
ACXX2013

Housing extension for F5 shower panels made of stainless steel

2030057069
ACXX2014

Housing extension for F5 shower panels made of stainless steel

2030057070
ACXX2015

Spare Parts

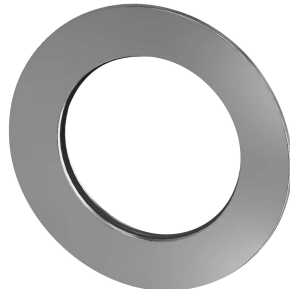
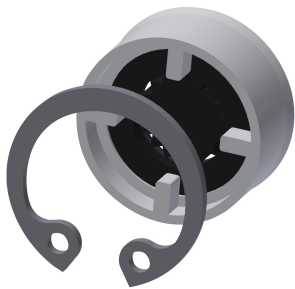



KWC F5L-Therm
Stainless steel shower panel

Modell-Linie: F5L | F5LT2022
Showers | Manual shower

Flow controller 9,0 l/min

2000104782
ESHHE0001

Rosette

2030048765
ASET2006

Stainless steel care set

2000109019
ZWSPL0024