

KWC F5L-Therm Shower panel made of MIRANIT

Modell-Linie: F5L | F5LT2024
Showers | Manual shower

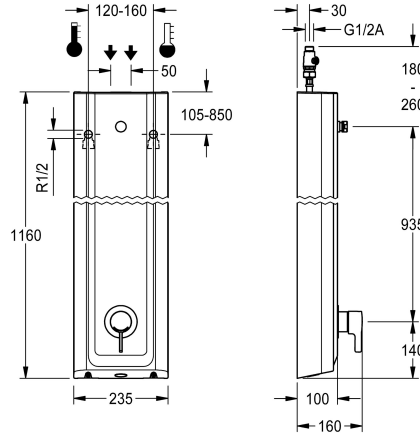

KWC-No.

2030066543

F5L-Therm shower panel made from mineral material for wall mounting with single-lever thermostat DN 15 and connecting nozzle for shower head. For connection to hot and cold water. Function block with integrated mixing cartridge and pre-assembled hygiene unit including sensor with control electronics to perform automatic water hygiene flushing, program-controlled thermal disinfection (additional bypass solenoid-operated flush valve cartridge necessary) and storage of statistical data. Thermostatically-controlled mixer cartridge with expansion element and active scald protection as well as adjustable and turn-proof temperature stop, and ceramic disc technology. All-metal construction, visible parts high-polished, chrome-plated. Connecting nozzles for separate required DN 15 KWC shower head with pre-fitted flow regulator 9.0 l/min. Housing with raised function surface made of MIRANIT resin-

bonded mineral material with pore-free smooth surface (temperature-resistant up to 80 °C), Alpine white colour. With adjustable and lockable connections with backflow preventer and strainers. Activated hygiene flushing, fixed interval of 24 hours. With option for parameterization and communication via optional, bidirectional remote control. Optional hygiene unit for battery operation with 6 V lithium battery (CR-P2) per fitting or separate power supply via plug-in power supply unit 6.75 V/12 V DC.

Housing dimensions 235 x 1160 x 100 mm (W x H x D)

Shower head and battery compartment including battery or power supply unit with extension cable must be ordered separately.

Technical Data

| | |
|--------------------------------|-------------------------|
| additional connections | no |
| with backflow preventer | yes |
| circulation | no |
| compatible A3000 open | no |
| connection with pay water disp | not possible |
| default automatic hygiene flus | fixed interval 24 hours |
| with filter | yes |
| adjustable flow time | no |
| functional principle | manual |
| for hand shower | no |
| hygiene flushing | yes |
| diameter nominal | DN 15 |
| inlet size | G 1/2 A |
| Locking mechanism | Top section, ceramic |
| material casing | mineral material |
| material code casing | Miranit |
| material fitting | brass-look |
| minimum flow pressure | 1 bar |
| type of mixing | with thermostat |
| overall depth | 100 mm |

| | |
|--------------------------------|-------------------------|
| additional connections | no |
| with backflow preventer | yes |
| circulation | no |
| compatible A3000 open | no |
| connection with pay water disp | not possible |
| default automatic hygiene flus | fixed interval 24 hours |
| with filter | yes |
| adjustable flow time | no |
| functional principle | manual |
| for hand shower | no |
| hygiene flushing | yes |
| diameter nominal | DN 15 |
| inlet size | G 1/2 A |
| Locking mechanism | Top section, ceramic |
| material casing | mineral material |
| material code casing | Miranit |
| material fitting | brass-look |
| minimum flow pressure | 1 bar |
| type of mixing | with thermostat |
| overall depth | 100 mm |

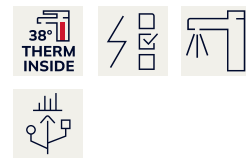

KWC F5L-Therm Shower panel made of MIRANIT

Modell-Linie: F5L | F5LT2024
Showers | Manual shower

| | |
|-------------------------------|----------------------------|
| overall height | 1,160 mm |
| overall width | 235 mm |
| Parameterization | remote control |
| power supply connection | 6,75 / 12 VDC |
| position of power connection | from top / backside |
| Type of power supply | Other |
| with rosettes/cover plate | yes |
| protective shutdown | no |
| shower pipe draining | no |
| Shower head | for separately shower head |
| with shower set | no |
| sound insulation | no |
| surface finish fitting | chromed |
| surface treatment fitting | polished |
| temperature limit | yes |
| thermal disinfection | yes |
| with transformer/power supply | no |
| type of mounting | wall mounting |
| type of operation | manual operation |
| type of sensor | opto-electronic sensor |
| type of shower | shower panel |
| volume flow rate at 3 bar | 0.15 l/s |
| water connection | hose (gland nut) |
| position of water connection | from top / backside |
| with soap dish | no |
| Accent colour | chrome-look (glossy) |
| Basic colour | white |

Mandatory Accessories



AQUAJET-Slimline shower head for KWC shower panels and systems

2030054255
SHAS0011



AQUAJET-Comfort shower head for KWC shower panels and systems

2030054254
SHAC0011



MÜNCHEN shower head for KWC shower panels and systems

2030054793
SHMU0011



Battery compartment

360002063
ACEX9023

KWC F5L-Therm Shower panel made of MIRANIT

Modell-Linie: F5L | F5LT2024
Showers | Manual shower

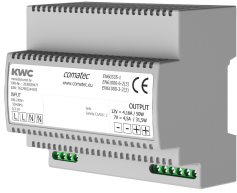

Power supply unit

2030039477
ACEX9001

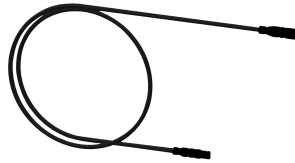

Extension cable 5 m

2030043814
ACEX9010

Optional Accessories

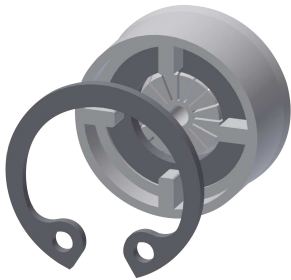

Flow controller 6.0 l/min

2030027586
ESHHE0004

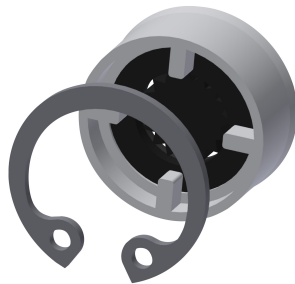

Flow controller 12.0 l/min

2000104783
ESHHE0002



Solenoid valve cartridge

2030003033
EAQFU0001



Housing extension for F5 shower panels made of MIRANIT

2030057071
ACXX2016



Housing extension for F5 shower panels made of MIRANIT

2030057072
ACXX2017



Housing extension for F5 shower panels made of MIRANIT

2030057073
ACXX2018



Housing extension for F5 shower panels made of MIRANIT

2030057075
ACXX2019



Housing extension for F5 shower panels made of MIRANIT

2030057076
ACXX2020

KWC F5L-Therm Shower panel made of MIRANIT

Modell-Linie: F5L | F5LT2024
Showers | Manual shower



2-button remote control for fittings F3 and F5

2030036849
ACEX9004



Bidirectional remote control for electrical fittings F3 and F5

2030036654
ACEX9005

Spare Parts

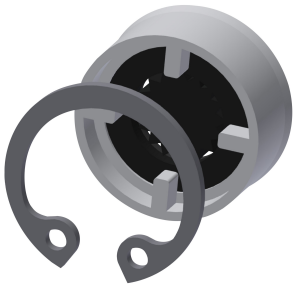

Flow controller 9,0 l/min

2000104782
ESHHE0001

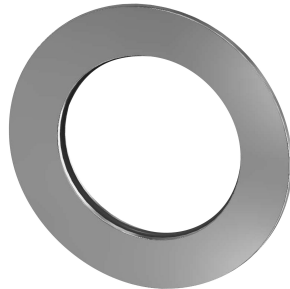

Rosette

2030048765
ASET2006



Solenoid valve cartridge

2030003033
EAQFU0001