

KWC F5L-Therm Shower panel made of MIRANIT with hand shower fitting

Modell-Linie: F5L | F5LT2025
Showers | Manual shower

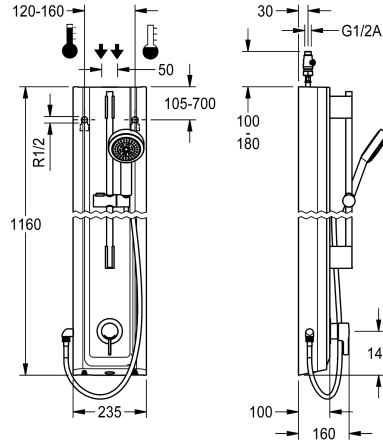

KWC-No.

2030066544

F5L-Therm shower panel made from mineral material for wall mounting with single-lever thermostat DN 15 and hand shower fitting kit. For connection to hot and cold water. Function block with integrated mixing cartridge and pre-assembled hygiene unit including sensor with control electronics to perform automatic water hygiene flushing, program-controlled thermal disinfection (additional bypass solenoid-operated flush valve cartridge necessary) and storage of statistical data. Thermostatically-controlled mixer cartridge with expansion element and active scald protection as well as adjustable and turn-proof temperature stop, and ceramic disc technology. All-metal construction, visible parts high-polished, chrome-plated. Pre-fitted chrome-plated brass shower rail with height-adjustable hand shower holder and chrome-plated plastic hand shower, shower head with rain jet, diameter 110 mm, shower hose 900 mm. Housing with raised function

surface made of MIRANIT resin-bonded mineral material with pore-free smooth surface (temperature-resistant up to 80 °C), Alpine white colour. With adjustable and lockable connections with backflow preventer and strainers. Activated hygiene flushing, fixed interval of 24 hours. With option for parameterization and communication via optional, bidirectional remote control. Optional hygiene unit for battery operation with 6 V lithium battery (CR-P2) per fitting or separate power supply via plug-in power supply unit 6.75 V/12 V DC.

Housing dimensions 235 x 1160 x 100 mm (W x H x D)

Battery compartment including battery or power supply unit with extension cable must be ordered separately.

Technical Data

additional connections	no
with backflow preventer	yes
circulation	no
compatible A3000 open	no
connection with pay water disp	not possible
default automatic hygiene flus	fixed interval 24 hours
with filter	yes
adjustable flow time	no
functional principle	manual
for hand shower	yes
hygiene flushing	yes
diameter nominal	DN 15
inlet size	G 1/2 A
Locking mechanism	Top section, ceramic
material casing	mineral material
material code casing	Miranit
material fitting	brass-look
minimum flow pressure	1 bar
type of mixing	with thermostat
overall depth	100 mm

no
yes
no
no
not possible
fixed interval 24 hours
yes
no
manual
yes
yes
DN 15
G 1/2 A
Top section, ceramic
mineral material
Miranit
brass-look
1 bar
with thermostat
100 mm



KWC F5L-Therm

Shower panel made of MIRANIT with hand shower fitting

Modell-Linie: F5L | F5LT2025

Showers | Manual shower

overall height	1,160 mm
overall width	235 mm
Parameterization	remote control
power supply connection	6,75 / 12 VDC
Type of power supply	Other
with rosettes/cover plate	yes
protective shutdown	no
shower pipe draining	no
with shower set	yes
sound insulation	no
surface finish fitting	chromed
surface treatment fitting	polished
temperature limit	yes
thermal disinfection	yes
with transformer/power supply	no
type of mounting	wall mounting
type of operation	manual operation
type of sensor	opto-electronic sensor
type of shower	shower panel
volume flow rate at 3 bar	0.15 l/s
water connection	hose (gland nut)
position of water connection	from top / backside
with soap dish	no
Accent colour	chrome-look (glossy)
Basic colour	white

Mandatory Accessories

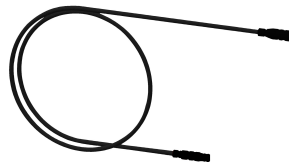
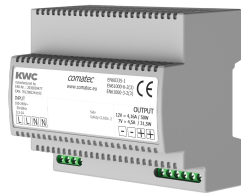

Battery compartment

3600002063
ACEX9023

Power supply unit

2030039477
ACEX9001

Extension cable 5 m

2030043814
ACEX9010

Optional Accessories

KWC F5L-Therm

Shower panel made of MIRANIT with hand shower fitting

Modell-Linie: F5L | F5LT2025

Showers | Manual shower

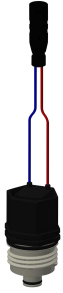

Solenoid valve cartridge

2030003033
EAQFU0001



Housing extension for F5 shower panels made of MIRANIT

2030057071
ACXX2016



Housing extension for F5 shower panels made of MIRANIT

2030057072
ACXX2017



Housing extension for F5 shower panels made of MIRANIT

2030057073
ACXX2018

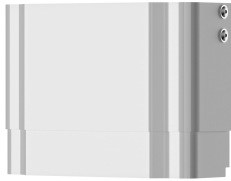

Housing extension for F5 shower panels made of MIRANIT

2030057075
ACXX2019

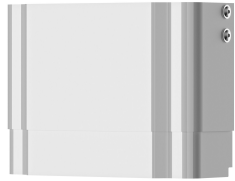

Housing extension for F5 shower panels made of MIRANIT

2030057076
ACXX2020



Bidirectional remote control for electronic fittings F3 and F5

2030036654
ACEX9005



2-button remote control for fittings F3 and F5

2030036849
ACEX9004

Spare Parts



Hand shower

2030051216
ACXX2007

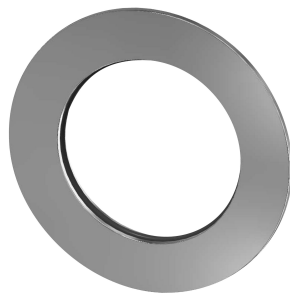

Rosette

2030048765
ASET2006



Solenoid valve cartridge

2030003033
EAQFU0001