

KWC F3E-Therm electronic thermostat mixer

Modell-Linie: F3E | F3ET2004
Showers | Electronic self closing shower

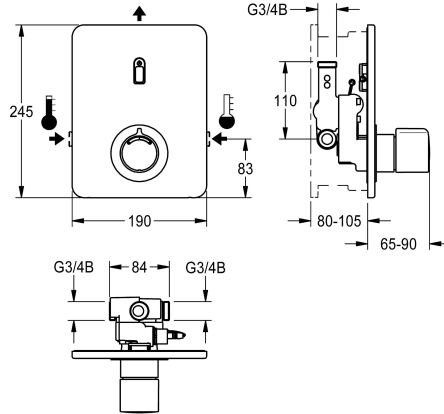

KWC-No.

2030067170

F3E-Therm thermostatic mixer DN 15 as finished installation kit for wall mounting in mounting material, for shower facilities. Electrically controlled, connects to hot water and cold water. Function block with integrated solenoid valve cartridge and thermostat, with metal handle with adjustable and turn-proof temperature stop and option for manual thermal disinfection. All-metal construction, visible parts high-polished, chrome-plated. With holding frame and profile seal, stainless-steel cover plate 190 x 245 mm with covered screw fixing including sensor with control electronics, rosette, backflow preventers and strainers. Depth adjustability 25 mm. Activated

hygiene flushing 24 hours after last activation and storage of statistical data. With option for parameterization and communication via optional, bidirectional remote control.

Either for battery operation with 6 V lithium battery (CR-P2) per fitting or separate power supply via power supply unit 6.75 V/12 V DC.

Battery compartment including battery or power supply unit with extension cable must be ordered separately.

Technical Data

additional connections	no
with backflow preventer	yes
Built-in fitting model	Finishing section
calculation flow rate cold wat	0.15 l/s
calculation flow rate hot wate	0.15 l/s
circulation	no
compatible A3000 open	no
connection with pay water disp	not possible
default automatic hygiene flus	24h after the last activity
default flow time	30 Seconds
with filter	yes
adjustable flow time	yes
functional principle	electronic self-closing
for hand shower	no
hygiene flushing	yes
diameter nominal	DN 15
inlet size	G 3/4 B
Locking mechanism	Top section, non-ceramic
material casing	stainless steel
material fitting	brass
maximum flow time	255 Seconds
minimum flow pressure	1 bar

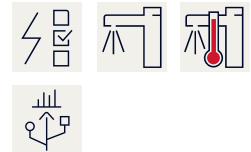

KWC

F3E-Therm electronic thermostat mixer

Modell-Linie: F3E | F3ET2004

Showers | Electronic self closing shower

minimum flow time	1 Seconds
type of mixing	with thermostat
Parameterization	remote control
power supply connection	6,75 / 12 VDC
position of power connection	from top
power consumption	1.5 Voltampere
Type of power supply	Transformer
with rosettes/cover plate	yes
protective shutdown	yes
shower pipe draining	no
sound insulation	no
surface finish casing	satin finished
surface finish fitting	chromed
surface treatment fitting	polished
temperature limit	yes
thermal disinfection	manual thermal disinfection
with transformer/power supply	no
type of mounting	in-wall installation with box
type of operation	sensor operation
type of sensor	opto-electronic sensor
type of shower	in-wall fitting
volume flow rate at 3 bar	0.23 l/s
water connection	threaded connection (external)
position of water connection	from side
Accent colour	chrome-look (glossy)
Basic colour	stainless steel

Mandatory Accessories

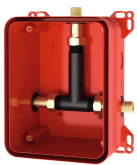

R3 System box for in-wall mixers

2030036141
F3BX2001



R5 System box for in-wall mixer

2030028990
F5BX2001



Power supply unit

2030039477
ACEX9001

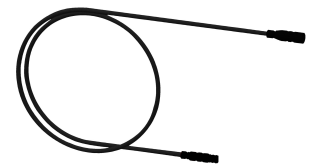

Extension cable 5 m

2030043814
ACEX9010

Optional Accessories

KWC

F3E-Therm electronic thermostat mixer

Modell-Linie: F3E | F3ET2004

Showers | Electronic self closing shower

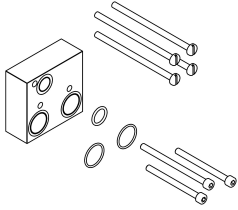

Extension set

2030067889
ACXT9001

Bidirectional remote control for electrical fittings F3 and F5

2030036654
ACEX9005

2-button remote control for fittings F3 and F5

2030036849
ACEX9004

Spare Parts

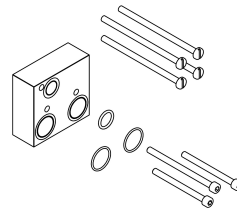
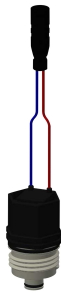
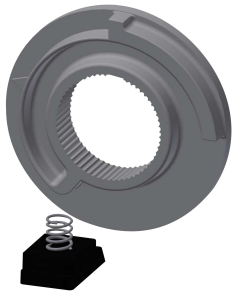

Temperature stop

2030003296
EAQLT0003

Solenoid valve cartridge

2030003033
EAQFU0001

Extension set

2030067889
ACXT9001

Cleaning product CHROMOL

2000105091
ZWSPL0023



Stainless steel care set

2000109019
ZWSPL0024