

KWC CAMPUS

Wall hung WC pan, barrier-free

Modell-Linie: CAMPUS | CMPX594GN

WCs and urinals | WCs

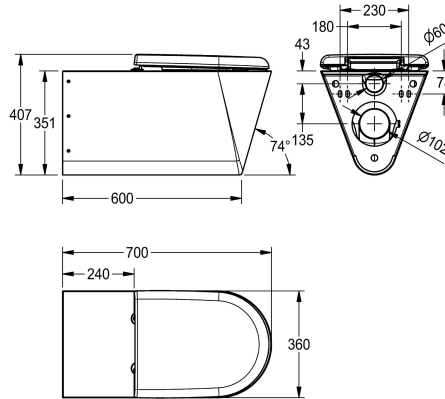

KWC-No.

2000100147

Without toilet seat

2000100148

With 2 toilet seat pads

3600000652

With black toilet seat

3600000653

With grey toilet seat

3600000654

With white toilet seat

type of toilet seat

no seat

synthetic seat pad

synthetic hinged seat with lid

synthetic hinged seat with lid

synthetic hinged seat with lid

Wall hung WC pan for disabled, stainless steel, surface satin finished, material thickness 1.5 mm, flushing certificated to EN 997, concealed flushing rim with min. 4 liter flushing capacity, with a shrouded 100 mm diameter horizontal 'P' trap outlet, pressed seat area tapered towards centre, all edges curved, fixing with included

mounting plate conform to EN 33, includes safety screws.

With grey WC-seat

Dimensions 360 x 407 x 700 mm (W x H x D)

Technical Data

barrier-free

inlet size

material

material code

material thickness

minimum flushing capacity

outlet size

overall depth

overall height

overall width

toilet seat colour

surface finish

type of mounting

type of toilet seat

type of WC

yes

DN 55

stainless steel

1.4301 Chrome Nickel steel V2A

1.5 mm

4 Liter

DN 100

700 mm

407 mm

360 mm

grey

satin finished

wall mounting

synthetic hinged seat with lid

wall hung

Spare Parts

KWC CAMPUS

Wall hung WC pan, barrier-free

Modell-Linie: CAMPUS | CMPX594GN

WCs and urinals | WCs



Toilet seat

360000624
ECMPX592-SEATGN

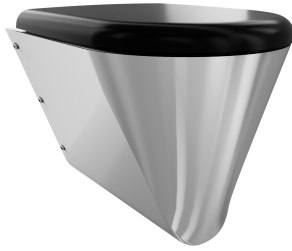

Toilet seat

360000626
ECMPX592-SEATBN



Toilet seat

360000627
ECMPX592-SEATWN

Hinge

360000658
ECMPX0058N