

KWC CAMPUS CAMPUS Floor standing WC pan

Modell-Linie: **CAMPUS | CMPX597GN**
WCs and urinals | WCs

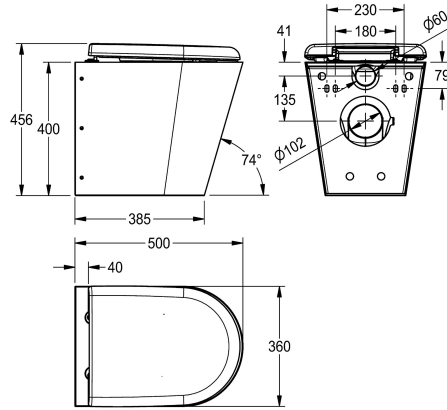

KWC-No.

2000100153

Version for installation from the front, with mounting plate and anti-theft screw fixings

2000100154

With 2 toilet seat pads

3600000655

With black toilet seat

3600000656

With grey toilet seat

3600000657

With white toilet seat

type of toilet seat

no seat

synthetic seat pad

synthetic hinged seat with lid

synthetic hinged seat with lid

synthetic hinged seat with lid

Floor standing WC pan with shroud to the floor, stainless steel, surface satin finished, material thickness 1,5 mm, flushing certificated to EN 997, concealed flushing rim with min. 4 litre flushing capacity, with a shrouded 100 mm diameter horizontal 'P' trap outlet, pressed seat area tapered towards centre, all edges

curved, fixing with included mounting plate conform to EN 33, including safety screws. 4 litre flush EN997 approved.

With grey WC-seat

Dimensions 360 x 456 x 500 mm (W x H x D)

Technical Data

inlet size
material
material code
material thickness
minimum flushing capacity
outlet size
overall depth
overall height
overall width
toilet seat colour
surface finish
type of mounting
type of toilet seat
type of WC

DN 55
stainless steel
1.4301 Chrome Nickel steel V2A
1.5 mm
4 Liter
DN 100
500 mm
456 mm
360 mm
grey
satin finished
wall mounting
synthetic hinged seat with lid
wall hung

Spare Parts

KWC CAMPUS CAMPUS Floor standing WC pan

Modell-Linie: **CAMPUS | CMPX597GN**
WCs and urinals | WCs



Toilet seat

360000624
ECMPX592-SEATGN

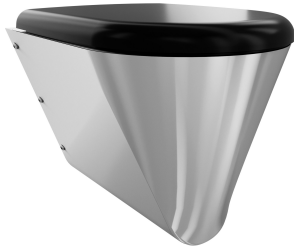

Toilet seat

360000626
ECMPX592-SEATBN



Toilet seat

360000627
ECMPX592-SEATWN

Hinge

360000658
ECMPX0058N
