

KWC MEDCARE Drip tray for MEDCARE dispenser

Modell-Linie: MEDCARE | CMEDC05T
Accessories | Complementary parts accessories

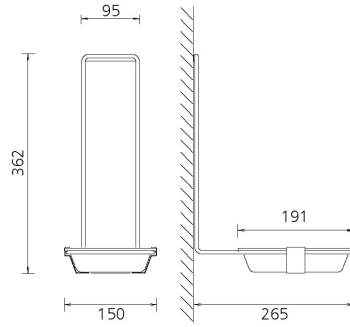
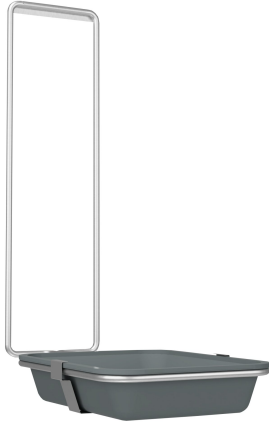

KWC-No.

360003362

Drip tray for MEDCARE dispenser, 500 ml

360003363

Drip tray for MEDCARE Spender, 1000 ml

Drip tray with holder, to hang over the dispenser housing, removable square plastic tray in grey, for MEDCARE dispenser 500 ml.

Dimensions 150 x 362 x 265 mm (W x H x D)

NEW

Technical Data

quantity
quantity uom

1
piece