

## KWC MEDCARE Drip tray for MEDCARE dispenser

Modell-Linie: MEDCARE | CMEDC05T  
Accessories | Complementary parts accessories

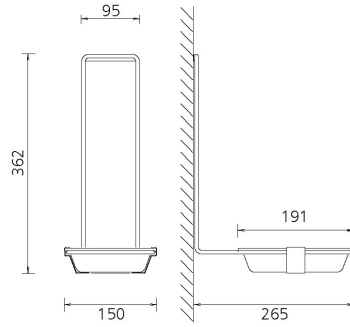
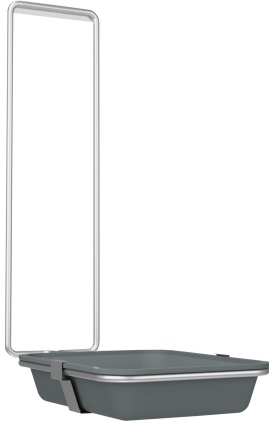

### KWC-No.

**360003362**

Drip tray for MEDCARE dispenser, 500 ml

**360003363**

Drip tray for MEDCARE Spender, 1000 ml

Drip tray with holder, to hang over the dispenser housing, removable square plastic tray in grey, for MEDCARE dispenser 500 ml.

Dimensions 150 x 362 x 265 mm (W x H x D)

NEW

### Technical Data

quantity
quantity uom

1
piece